

PRODUCT DATASHEET

DL SLIM DN 105 6 W 3000 K WT

DOWNLIGHT SLIM ROUND | Flat downlights with integrated driver, round shape

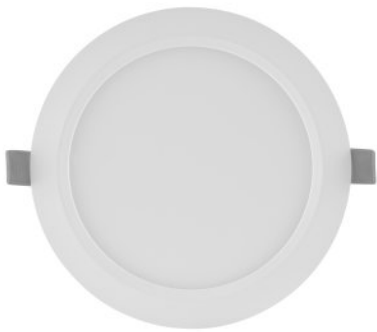

AREAS OF APPLICATION

- Direct replacement for luminaires with compact fluorescent lamps
- General illumination
- Public areas
- Stairways
- Corridors
- Foyers
- Shops

PRODUCT BENEFITS

- Very slim housing
- Low installation depth
- High luminous efficacy
- Energy savings up to 60 % (compared to luminaires that use CFL lamps)
- Very homogenous light
- Functional design
- Easy installation with fast connection
- Simple installation thanks to integrated driver

PRODUCT FEATURES

- Small visible bezel
- Connector box with push wire terminal for tool-free connection
- Light guide made of non-yellowing PMMA for long lifetime



TECHNICAL DATA

Electrical data

Nominal wattage	6.00 W
Operating mode	Electronic control gear (ECG)
Nominal voltage	220...240 V
Power factor λ	0.50
Mains frequency	50/60 Hz

Luminaire control gear data

Output current	180 mA
ECG - Output ripple current	<6.5 %

Photometrical data

Color temperature	3000 K
Luminous flux	420 lm
Luminous efficacy	70 lm/W
Standard deviation of color matching	<6 sdc _m
Light color (designation)	Warm White
Color rendering index Ra	>80
Luminous efficacy of lamp in luminaire	70 lm/W

Light technical data

Beam angle	120 °
------------	-------

Dimensions & weight

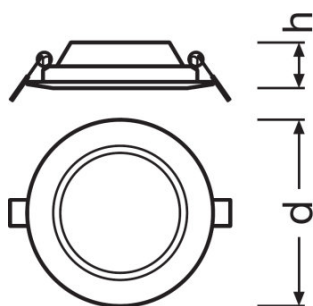

Diameter	118.0 mm
Height	30.0 mm
Product weight	158.00 g
Mounting diameter	105.0 mm

Colors & materials

Body material	Polycarbonate (PC)
Housing color	White
Product color	White

Temperatures & operating conditions

Ambient temperature range	-20...50 °C
----------------------------------	-------------

Lifespan

Lifespan L70 at 25 °C	30000 h
Number of switching cycles	50000

Additional product data

Mounting type	Recessed
Mounting location	Ceiling / Wall

Capabilities

Dimmable	No
Type of connection	Push button terminal, 2-pole
LED module replaceable	Not replaceable

Certificates & standards

Protection class IK (shock resistance)	IK03
Glow Wire Test according to IEC 695-2-1	650 °C
Photobiological safety group	RG 0
Protection class	II
Type of protection	IP20
Standards	CE/CB/EAC

Light Distribution

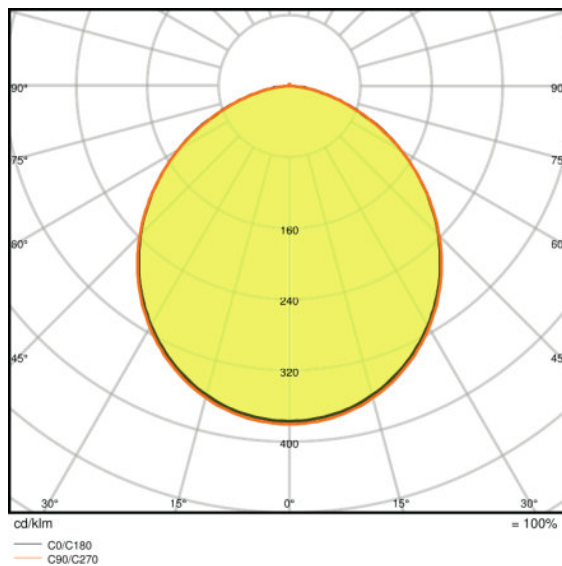
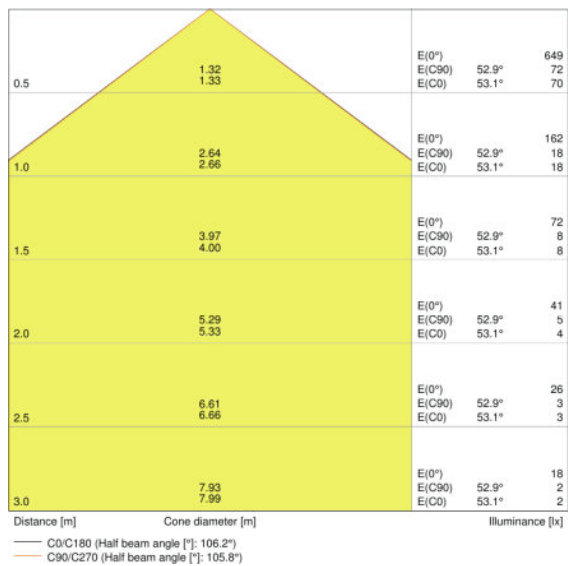

LDC typ cone

LDC typ polar

EQUIPMENT / ACCESSORIES

- Surface mounting frames available as accessories

LOGISTICAL DATA

Product code	Product description	Packaging unit (Pieces/Unit)	Dimensions (length x width x height)	Volume	Gross weight
4058075078970	DL SLIM DN 105 6 W 3000 K WT	Shipping carton box 6	290 mm x 165 mm x 165 mm	7.90 dm ³	1317.00 g

The mentioned product code describes the smallest quantity unit which can be ordered. One shipping unit can contain one or more single products. When placing an order, for the quantity please enter single or multiples of a shipping unit.

REFERENCES / LINKS

For Guarantee see
 ▶ www.ledvance.com/guarantee

DISCLAIMER

Subject to change without notice. Errors and omission excepted. Always make sure to use the most recent release.