

Installation must be installed by a qualified electrician (BS7671).
Read before installation and retain for future reference.
Always check for concealed pipes and cables before installation.

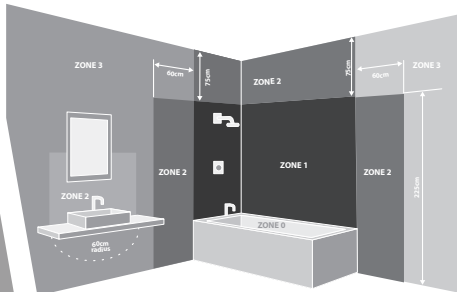

LOCATION

This product is suitable for zones 1 and 2 (not zone 0).

Zone 0: the area inside the bathtub or shower.

Zone 1: the area around the bathtub or shower basin up to a height of 2.25m above the floor and at a radius of 1.2m from the water outlet.

Zone 2: is limited by the vertical planes external to zone 1 and parallel vertical plane(s) 0.60m external to zone 1.

Ensure a minimum ceiling-void depth of 260mm is available.

In a bathroom, product must be supplied via a 30mA residual current device (RCD).

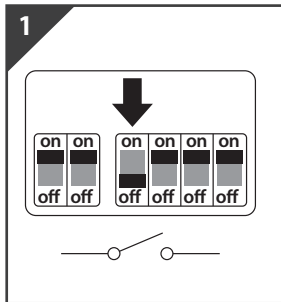

1 Switch OFF at mains supply before installing

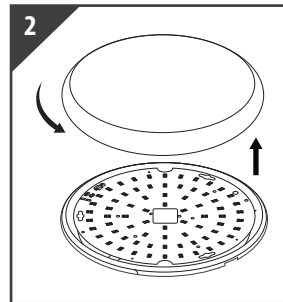

2 Hold the base securely and twist to unlock and remove the diffuser

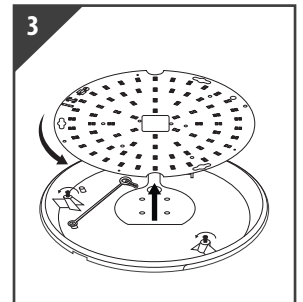

3 Loosen screws and twist to remove gear tray from the base, detach safety belt

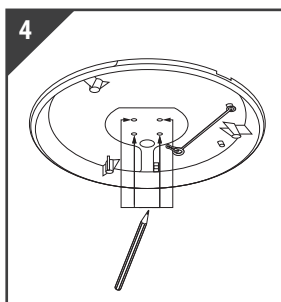

4 Ensure product is located in the correct location and mark surface

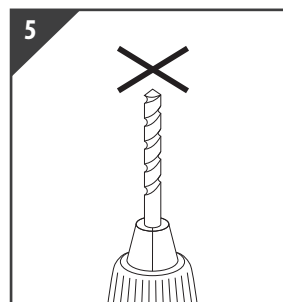

5 Use correct drill bit to drill screw holes

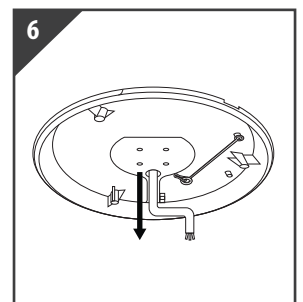

6 Pull power supply through hole in the base plate

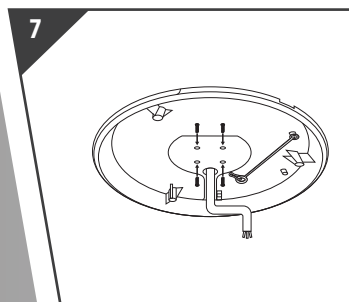

7 Install the fixing screws to the base plate

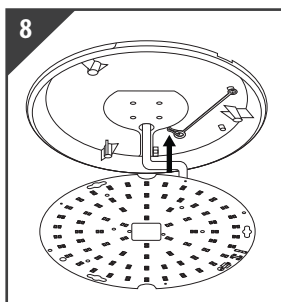

8 Attach safety belt to gear tray

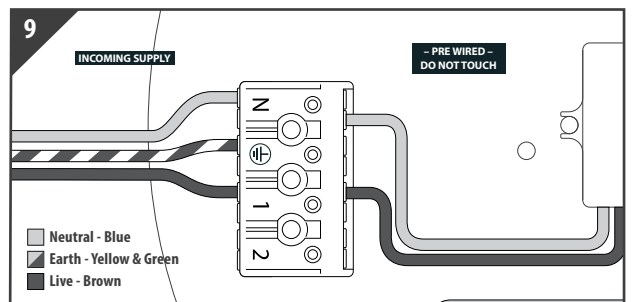

9 Press the individual terminal and insert the correct incoming supply before releasing the terminal to secure. The product **MUST** be earthed

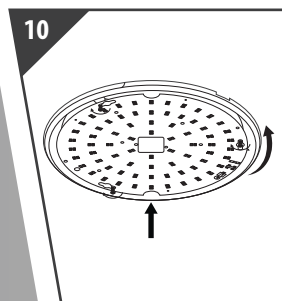

10 Align gear tray with screws and tighten

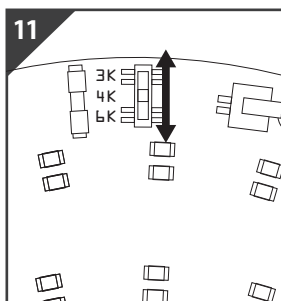

11 Use the CCT selection switch on the gear tray to select the desired colour temperature

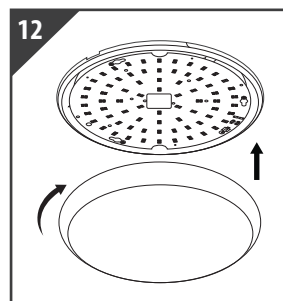

12 Push and twist the diffuser back into place

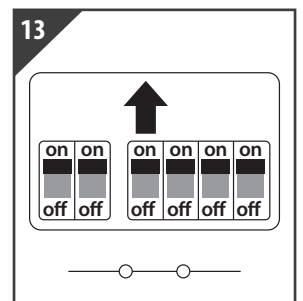

13 Return power. Switch ON at mains supply



DO NOT MODIFY – this will invalidate the warranty and could be dangerous.

Waste electrical products should not be disposed of with household waste. Please recycle where facilities exist. Check with your Local Authority or retailer for recycling advice.

INSTRUCTIONS CONTINUED OVERLEAF, PLEASE TURN OVER

S17474 - IP65 - 15W LED CCT Adjustable Microwave Polo Bulkhead

Wiring

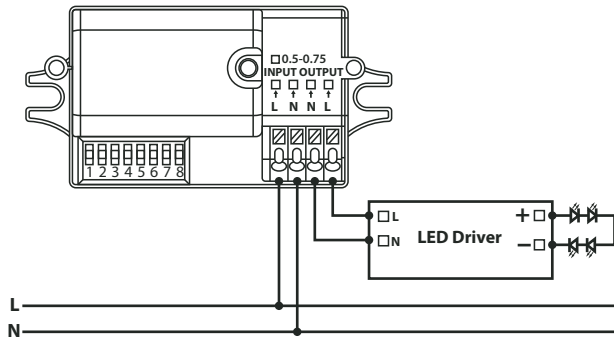

Structure

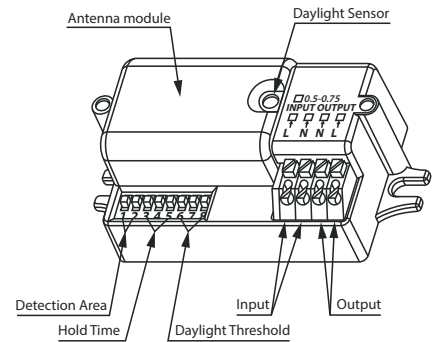

DIP Switch Settings

1&2 - Detection Area (Sensitivity)

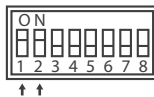

		1	2
I	100%	On	On
II	75%	On	-
III	50%	-	On
IV	25%	-	-

3, 4 & 5 - Hold Time

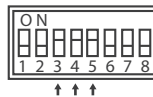

		3	4	5
I	5 Secs	On	On	On
II	30 Secs	On	On	-
III	1 Min	On	-	On
IV	3 Mins	On	On	-
V	5 Mins	-	On	On
VI	10 Mins	-	On	-
VII	20 Mins	-	-	On
VIII	30 Mins	-	-	-

6, 7 & 8 - Daylight Threshold

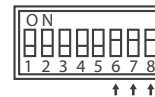

		6	7	8
I	2 Lux	On	On	On
II	10 Lux	On	On	-
III	25 Lux	-	On	-
IV	50 Lux	On	-	-
V	Disable	-	-	-

*Disable means the daylight sensor does not work. The sensor will turn on light once motion is detected regardless of ambient light level.

Factory Setting

Detection Area: 100%, Hold Time: 5secs, Daylight Sensor: Disable

Initialization

After power on, the sensor automatically turns on light at 100% brightness. During the initialization, the sensor is not able to detect movement.

Sensor Function

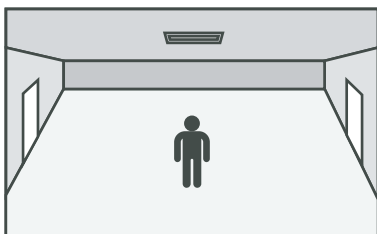

With sufficient ambient light, the light will not switch on even if motion is detected

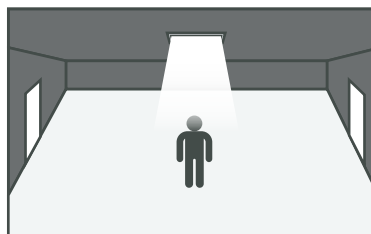

With insufficient ambient light, the sensor switched on the light when motion is detected.



Once the hold time is elapsed, the sensor switches off the light when motion is no longer detected.