

## Product Information

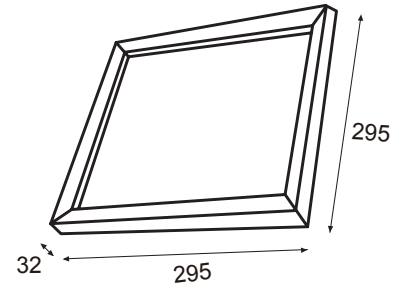

### Technical Specifications

Model	Size	Voltage	Power	LMW	Lumen (±5%)	Kelvin	LED Lens	Front Diff	Warranty	Hours	Type	Flicker free	Driver Brand	LED Brand	UGR	TPa/TPb	IP	Height	Power Factor	Beam angle	CRI
S16292	3030	AC 220-240V	18W	80	1440	CCT(4000K/5000K/6000K)	PMMA	PS	5	50,000.00	Backlit	Yes	Lifud	Sanan	<19	TPa	IP20	32mm	0.9	90°	>80

### Driver data Sheet

Driver data	DIM
Input rated Voltage	AC220-240V
Frequency	47Hz-63Hz
Input Voltage	AC198-264V
Efficiency	≥87.5%
Total load Wattage	18W
Power Factor	≥0.95
Rated input current	0.2A Max
Full load output Voltage	25-40Vdc
Rated output current	450mA
Output current range	400mA±5%
Power tolerance	±5%
Current output tolerance	±5%
Withstand voltage	3750V
Short circuit protection	PASS
Overload protection	PASS
No-load protection	PASS

### Fixture Compatibility

Rated Wattage	Electrical Classification	Ingress Protection	Operating Temp	Operating Humidity	Storage Temp
18W	II	IP20	-20 C ~ +45 C	20-90%RH	-20 C ~ + 80 C

## Spectral Distribution

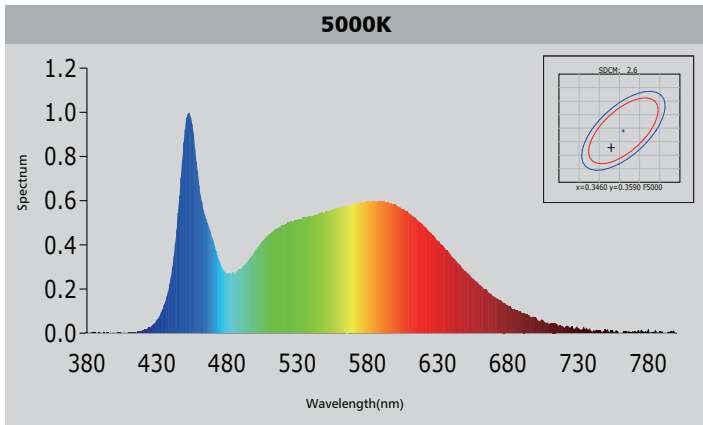
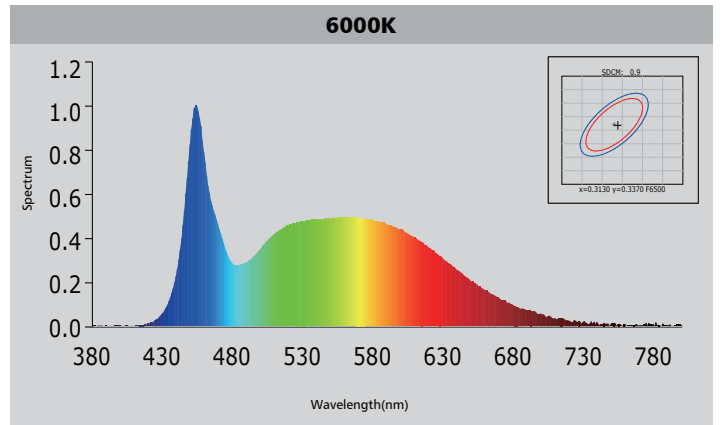
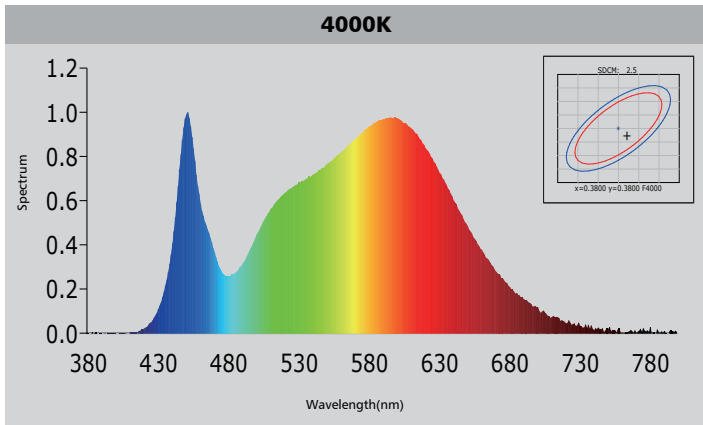

## Photometric Diagram

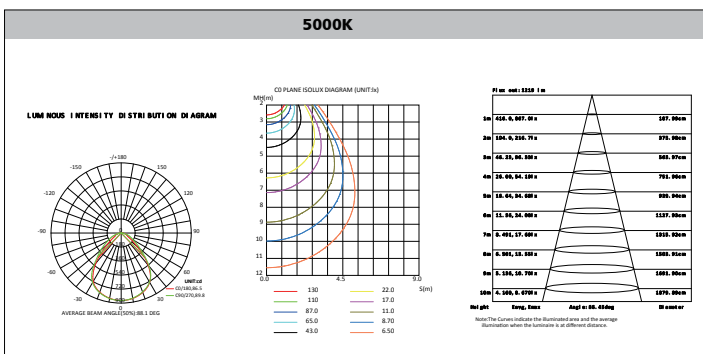
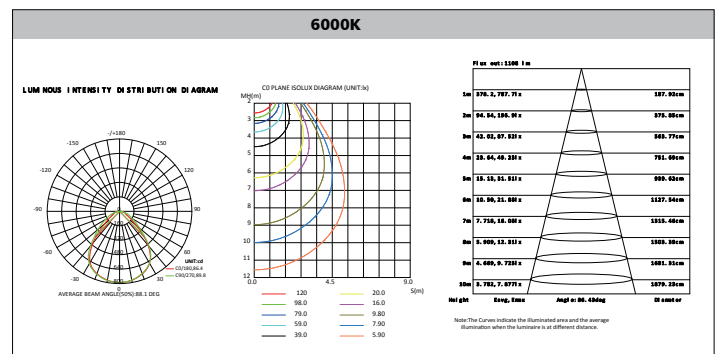
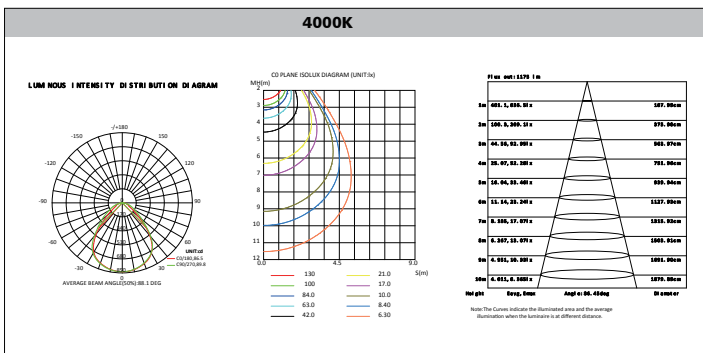

## Luminous Intensity Distribution Diagram

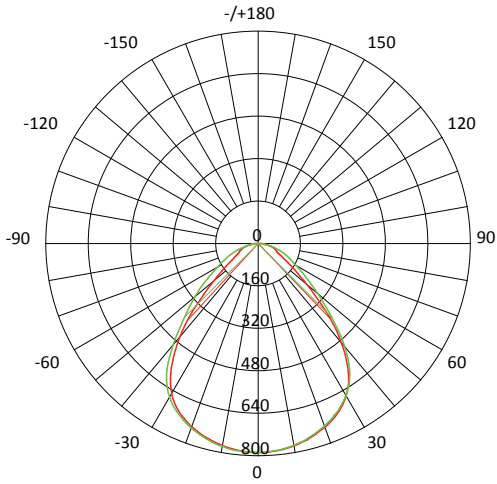

**UNIT : cd**  
 — C0/180 , 86.4  
 — C90/270 , 89.8

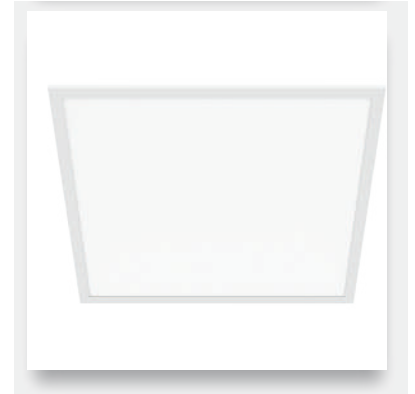

**AVERAGE BEAM ANGLE (50%) : 88.1 DEG**

## Average Lumen Maintenance and Chromaticity Shift VS. Time

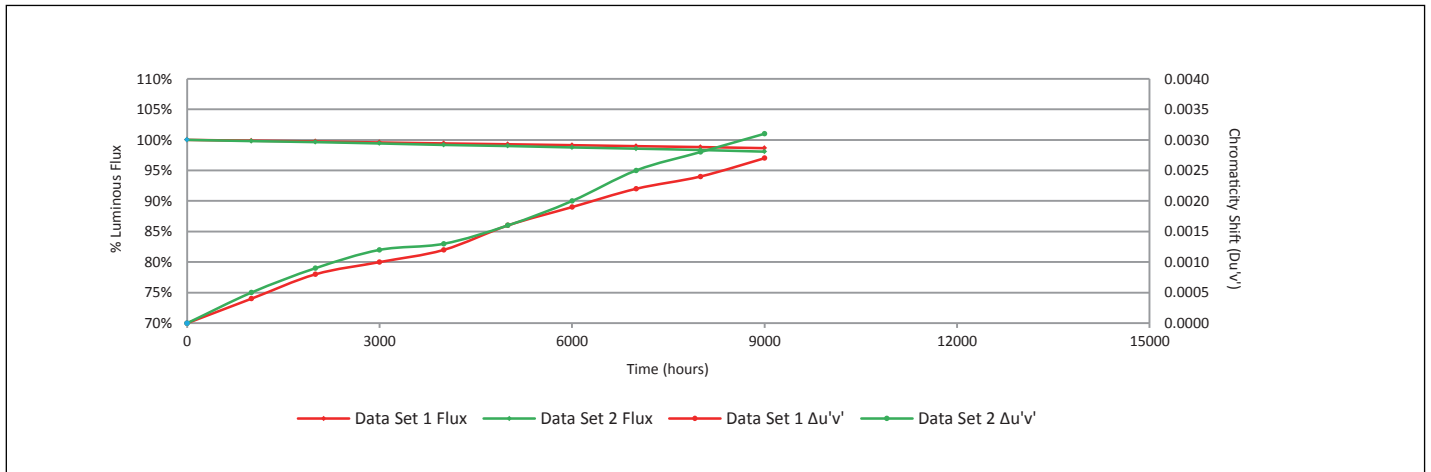

## Installation

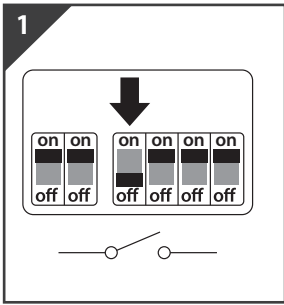

Switch OFF at mains supply before installing

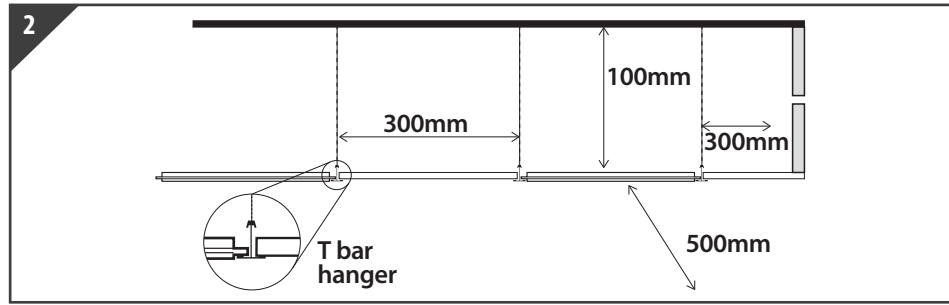

Ensure that there is adequate space for panel installation in suspended ceiling

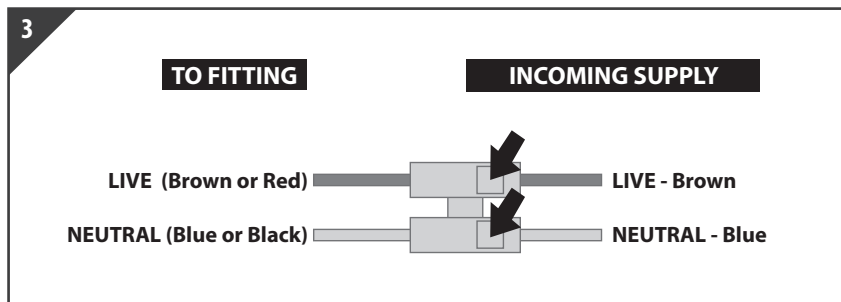

Insert correct supply and wiring from the driver into terminal block (not provided), tighten all screws in block

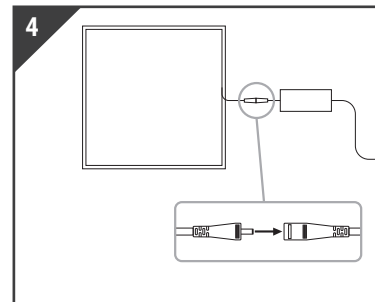

Connect driver to panel

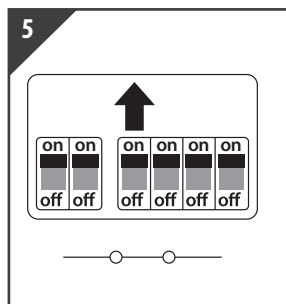

Return power. Switch ON at mains supply

## Packaging Information

	SIZE(CM)	N.W/pc (KGS)	G.W.(KGS)	Q'TY(PCS)
Carton	32*25.5*36.5	0.5	5	6

	CTNS	Q'TY(PCS)	VOLUME(CBM)
20" standard container	785	4710	27
40" standard container	1629	9768	56

