

LED ceiling-recessed luminaire

LED ceiling-recessed luminaire with uniform light surface. Product height of only 20 mm: fits various ceiling types. Replaces conventional downlights with 2 x 18 W CFL and offers up to 50 % energy saving. Connector for easy and tool-free wiring. Switchable colour temperature: choose between warm white (3000K) and neutral white (3500K) and cold white (4000K) to suit application use. Plug&Play with "Just Emergency E3 KIT" for 3h emergency operation. Dimensions: Ø180 x 26 mm. Body: aluminium, white finish (RAL9003). Diffuser: Polystyrol. weight: 0.4 kg.

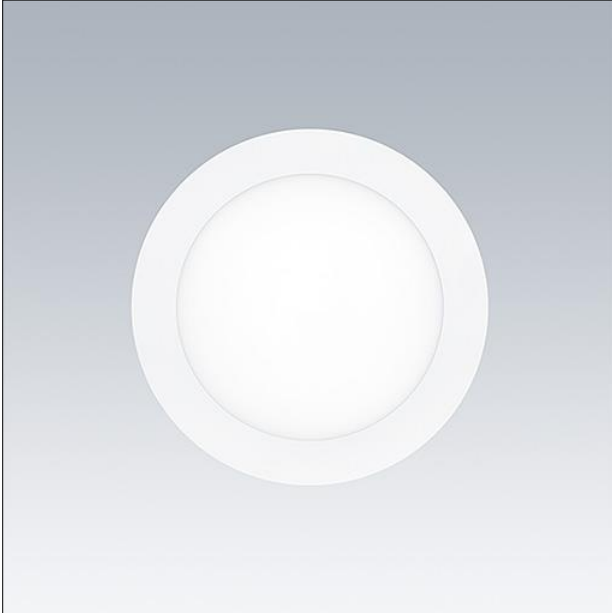

TE_ZOE_F_170.jpg

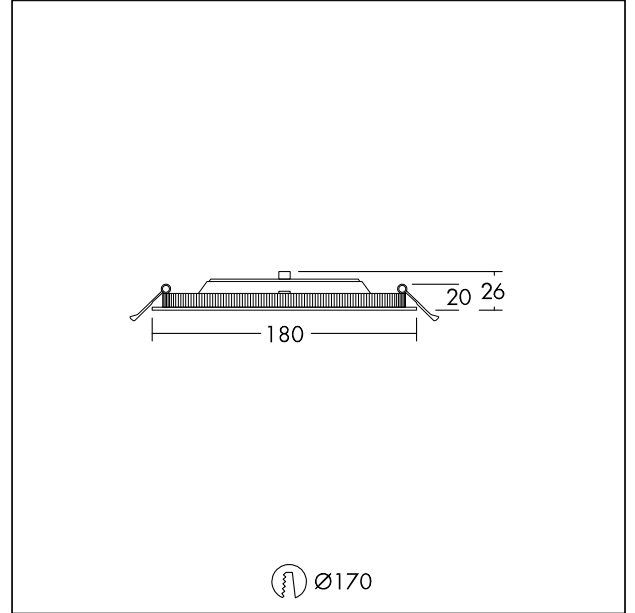

TE_ZOEVARIO_M_170.wmf

Light Distribution

STD - standard

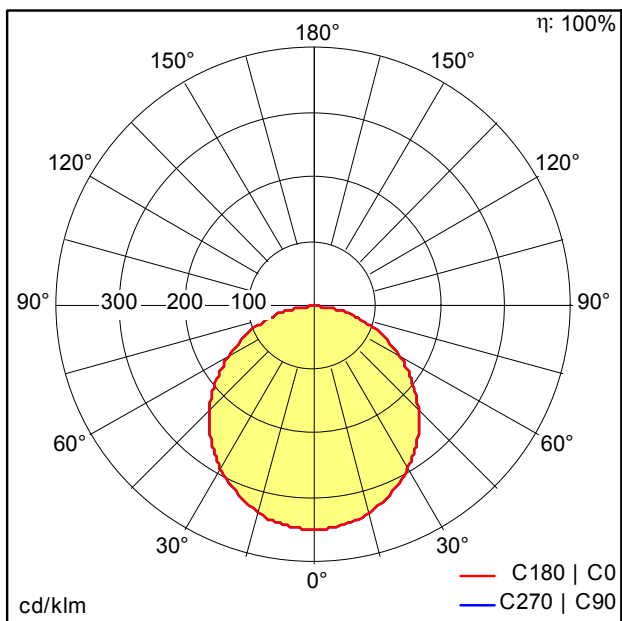

TE_ZOE_VARIO_LED_DL_170_1000_840.ltd

- Light Source: LED
- Luminaire luminous flux*: 1000 lm
- Luminaire efficacy*: 83 lm/W
- Colour Rendering Index min.: 80
- Correlated colour temperature: 3000-4000 Kelvin
- Chromaticity tolerance (initial MacAdam): 4
- Rated median useful life*: L70 50000h at 25°C
- Ballast: 1x LED_Con
- Luminaire input power*: 12 W Power factor = 0.9
- Dimming: Fixed output